

# wardrobes online

## DO IT YOURSELF INSTALLATION

### PARTS CHECKLIST



### TOOLS REQUIRED

TAPE MEASURE

PENCIL

DRILL

DRILL BITS (3.5, 5 AND 6mm)

SCREWDRIVER (POSI-DRIVE OR PHILLIPS)

SPIRIT LEVEL

ERASER

HACKSAW OR BOLT CUTTERS

# Pole Positions and examples

## Suggested shelf heights from floor (pre-drilled)

Example 1

Example 2

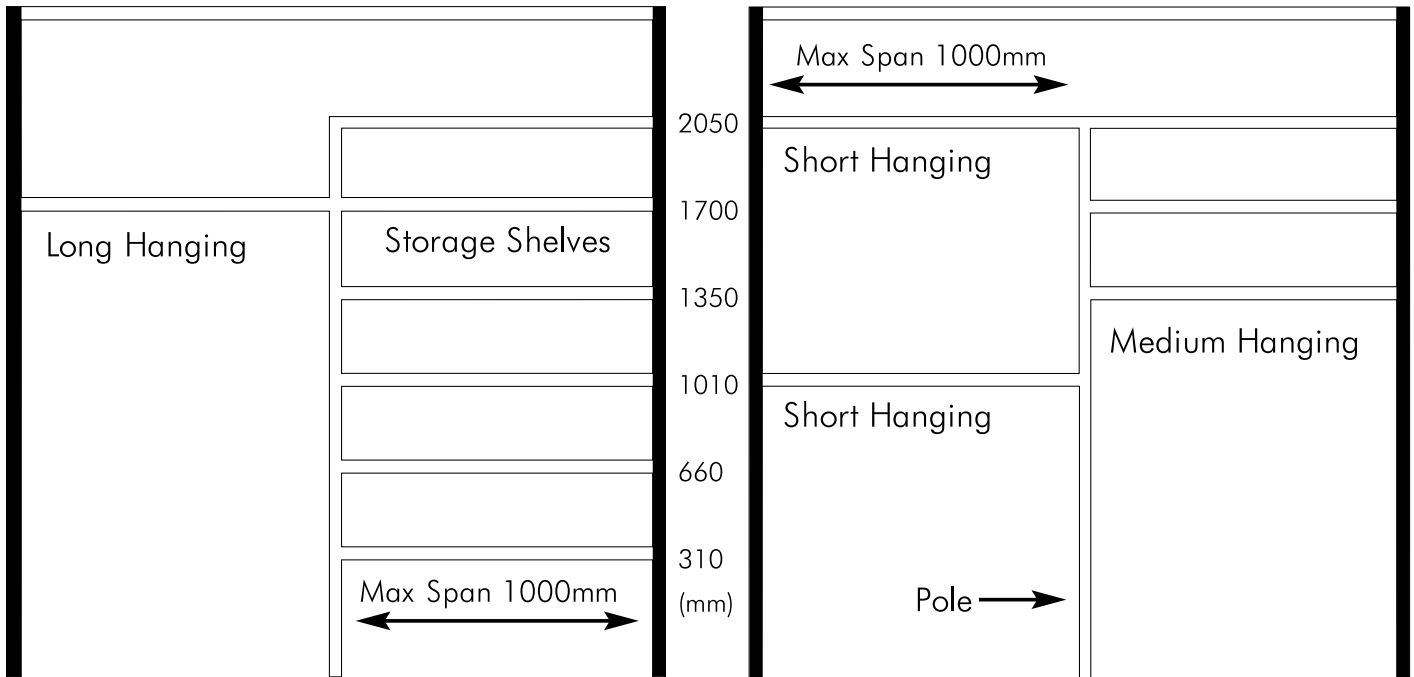

## STEP ONE

### CUTTING SHELVES

- It is advisable to lay shelving on the floor in its correct position before cutting.
- Shelving from wall to wall should be 20mm shorter than wall to wall measurement.
- If shelving overlaps and is fixed to the pole, ensure the overlap is at least one deck wire in from the end of each shelf. (See diagram)

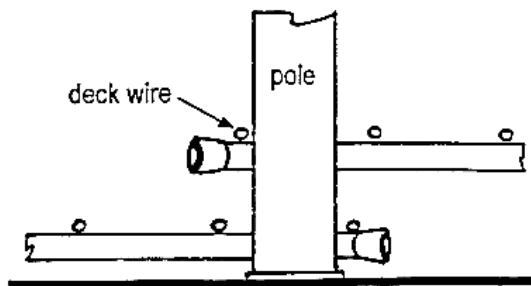

Cut using hacksaw or bolt cutters allowing for fitting of rubber rod end caps. Place rubber rod end caps on all shelves. If clothes hanging shelf needs to be cut, cut from both ends leaving the support struts on the shelf to retain full strength for the clothes hanging rail.

Add shelf and rod end(s) for extra strength if support strut has to be cut off.

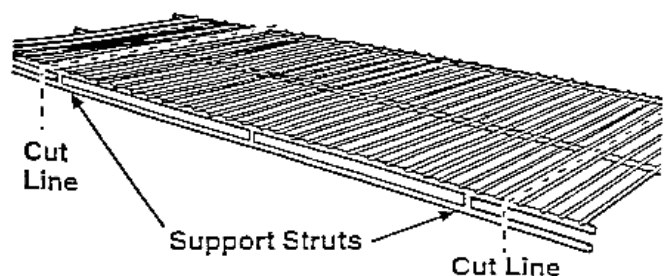

## STEP TWO

### POLE ASSEMBLY

- Assemble top and bottom sections of poles and pole end caps.
- Set pole clips with 12mm screw to pre-drilled holes or drill new holes using 3.5mm bit at required heights (See diagram).

Ensure screw holes are all facing the same way, you'll know they are joined correctly as all mounting holes are 330mm apart.

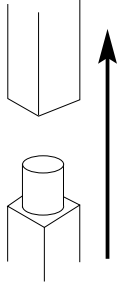

Poles inserted this way up

## STEP THREE

### MARKING FOR WALL CLIPS

- Using the pole as height guide for each shelf, mark with a pencil the first hole approx 40mm from each end of the shelf at the height of the pole screw (See diagram).

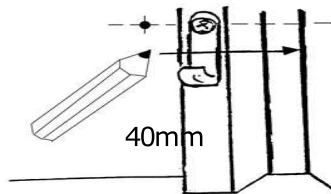

Hold the shelf up to the marks and mark other holes evenly spaced along the wall but no more than 300mm apart. (See diagram)

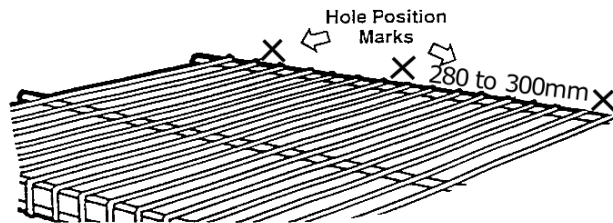

Before drilling holes, check that your marks line up level on the back wall

**NOTE:** If carpet is yet to be laid use a 10mm packer on bottom of pole to allow for this.

## STEP FOUR

### DRILLING HOLES

- Drill 5mm or slightly larger than your wall anchor into gib board holes. Push or tap in wall clips and secure using 25mm screws. Do not over tighten.
- If fixing to solid timber fix wall clips with anchor part cut off.

## STEP FIVE

### FIXING SHELVES TO WALL AND POLES

- For 300mm deep shelves, hang all shelves on wall clips in their correct positions.
- Swing the shelf up horizontally and push into the pole clips starting at the top shelf.
- For 400mm shelves, as the pole is clipped against the inside rail and not the very outer rail the shelves will need to be placed on the floor in the correct order and fed up the pole. (see diagram)

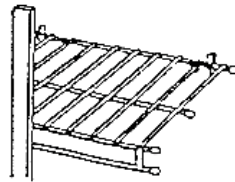

300mm

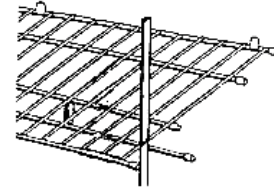

400mm

## STEP SIX

### FIXING WALL BRACKETS

- Place wall bracket on side wall holding shelf in position. Place a spirit level and adjust up or down to level.
- When in level position mark holes.
- Drill 6mm holes. Feed wall anchors through wall bracket. Push into holes and secure with 25mm screws. (diagram)

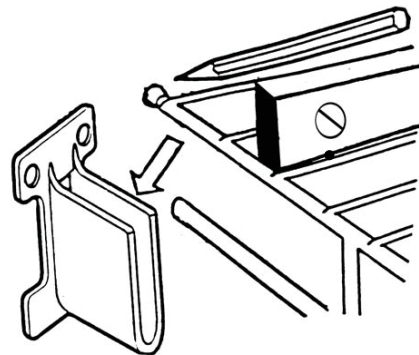

**Unless extra support or joints are required you have now completed your wardrobe organiser.**

## SUPPORT BRACKETS

Should be used where a span is more than 1000mm and a pole is not being used.

Attach the joiner plates and bracket arm to the front edge of the shelf with screw and nut supplied.

Hold shelf level and mark hole on wall for lower end of bracket arm. Drill, insert anchor, and screw bracket arm to wall.

Can also be used as joiner when two shelves meet at the same level.

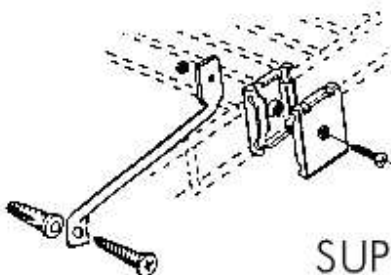

SUPPORT BRACKET

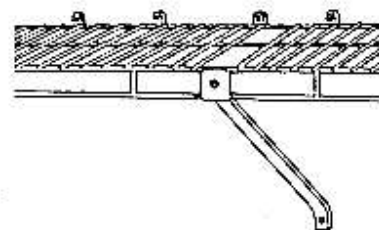

JOINER

**Wardrobes Online is a division of MAINTRADE LTD**  
**For any further enquiries please contact: Tel 0800 426 100**